

## Bridge Rectifiers

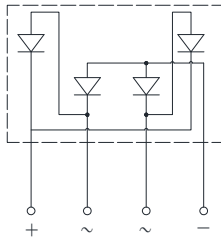
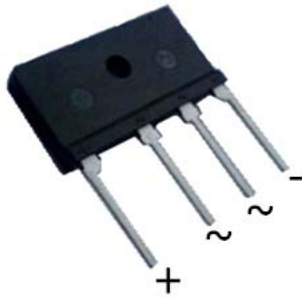

### Features

- UL recognition, file #E230084
- Glass passivated chip junction
- Thin single in-line package
- High surge current capability
- Solder dip 275 °C max. 7 s, per JESD 22-B106

### Typical Applications

General purpose use in AC/DC bridge full wave rectification for switching power supply, home appliances, office equipment, industrial automation applications.

### Mechanical Data

- **Package:** JA  
Molding compound meets UL 94 V-0 flammability rating, RoHS-compliant, Halogen free
- **Terminals:** Tin plated leads, solderable per J-STD-002 and JESD22-B102
- **Polarity:** As marked on body

### ■ Maximum Ratings ( $T_a=25^{\circ}\text{C}$ Unless otherwise specified)

PARAMETER	SYMBOL	UNIT	D8JA05	D8JA10	D8JA20	D8JA40	D8JA60	D8JA80	D8JA100
Device marking code			D8JA05	D8JA10	D8JA20	D8JA40	D8JA60	D8JA80	D8JA100
Maximum Repetitive Peak Reverse Voltage	VRRM	V	50	100	200	400	600	800	1000
Maximum RMS Voltage	VRMS	V	35	70	140	280	420	560	700
Maximum DC blocking Voltage	VDC	V	50	100	200	400	600	800	1000
Average Rectified Output Current @60Hz sine wave, R-load,	With heatsink $T_c = 118^{\circ}\text{C}$	IO	A	8.0					
	Without heatsink $T_a = 25^{\circ}\text{C}$			3.2					
Forward Surge Current (Non-repetitive) @60Hz Half-sine wave, 1 cycle, $T_j=25^{\circ}\text{C}$	IFSM	A	175						
Forward Surge Current (Non-repetitive) @1ms, square wave, 1 cycle, $T_j=25^{\circ}\text{C}$			350						
Current squared time @1ms≤t≤8.3ms $T_j=25^{\circ}\text{C}$ , rating of per diode	I <sup>2</sup> t	A <sup>2</sup> S	127						
Storage temperature	T <sub>stg</sub>	°C	-55 ~ +150						
Junction temperature	T <sub>j</sub>	°C	-55 ~ +150						
Dielectric strength @ Terminals to case, AC 1 minute	V <sub>dis</sub>	KV	2						
Mounting torque @Recommend torque: 5kg·cm	Tor	kg·cm	8						



# D8JA05 THRU D8JA100

## ■Electrical Characteristics (T<sub>a</sub>=25°C Unless otherwise specified)

PARAMETER	SYMBOL	UNIT	TEST CONDITIONS	D8JA05	D8JA10	D8JA20	D8JA40	D8JA60	D8JA80	D8JA100	
Maximum instantaneous forward voltage drop per diode	V <sub>F</sub>	V	IFM=4.0A								1.0
Maximum DC reverse current at rated DC blocking voltage per diode	I <sub>R</sub>	μA	T <sub>j</sub> =25°C								5
			T <sub>j</sub> =125°C								100
Typical junction capacitance	C <sub>j</sub>	pF	Measured at 1MHz and Applied Reverse Voltage of 4.0 V.D.C								53

## ■Thermal Characteristics (T<sub>a</sub>=25°C Unless otherwise specified)

PARAMETER		SYMBOL	UNIT	D8JA05	D8JA10	D8JA20	D8JA40	D8JA60	D8JA80	D8JA100	
Thermal Resistance	Between junction and ambient, Without heatsink	R <sub>θJ-A</sub>	°C/W								22
	Between junction and case, With heatsink	R <sub>θJ-C</sub>									2

Note: Device mounted on 75mm x 45mm x 5.5mm Aluminum Plate Heatsink.

## ■Ordering Information (Example)

PREFERRED P/N	PACKAGE CODE	UNIT WEIGHT(g)	MINIMUM PACKAGE(pcs)	INNER BOX QUANTITY(pcs)	OUTER CARTON QUANTITY(pcs)	DELIVERY MODE
D8JA05 ~ D8JA100	B1	Approximate 4.3	15	750	1500	Tube

## ■ Characteristics(Typical)

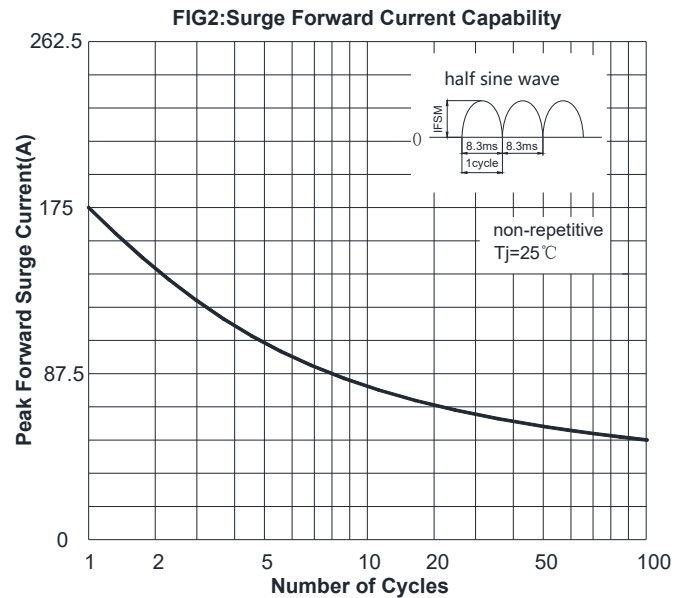
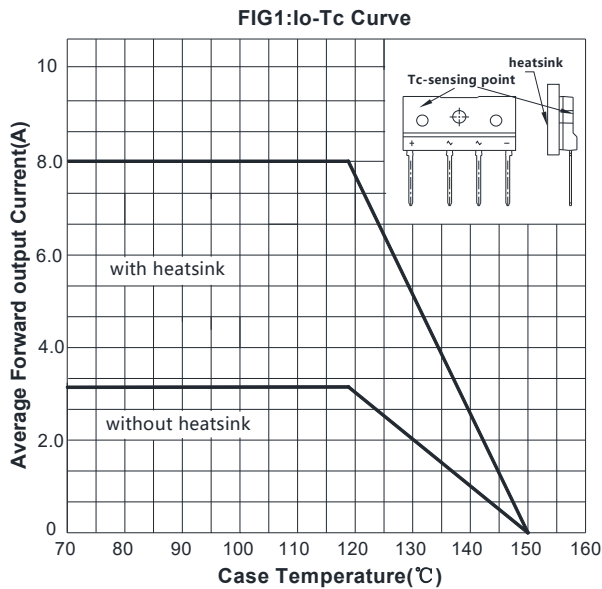



# D8JA05 THRU D8JA100

FIG3: Typical Forward Voltage

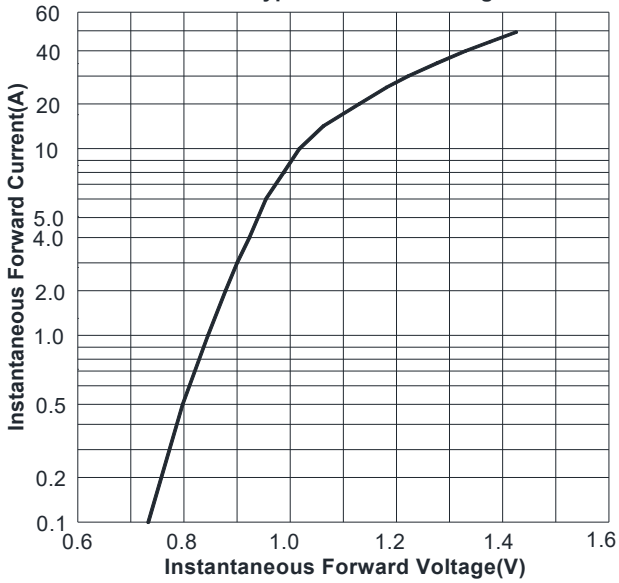
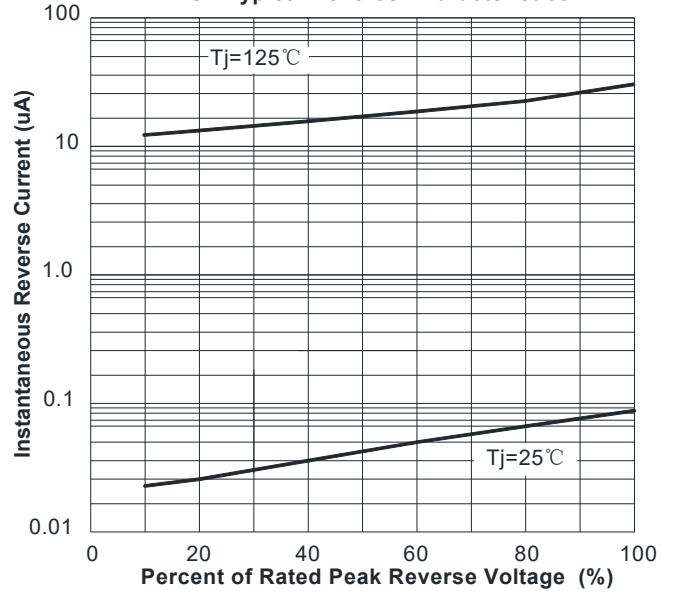
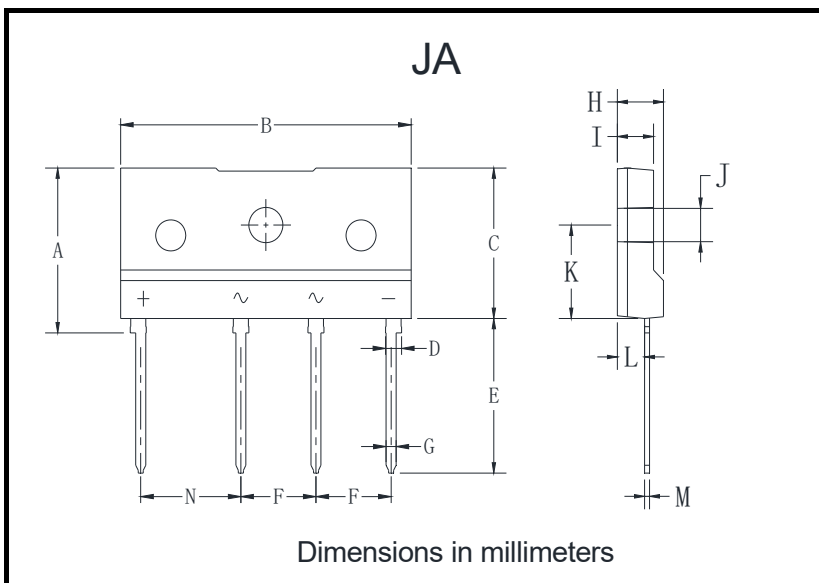

FIG4: Typical Reverse Characteristics



## Outline Dimensions



JA		
Dim	Min	Max
A	15.6	16.2
B	28.7	29.3
C	14.2	14.8
D	1.5	1.7
E	14.6	15.2
F	7.3	7.7
G	0.9	1.1
H	4.3	4.9
I	3.3	3.9
J	3.1	3.4
K	8.7	9.3
L	2.5	2.9
M	0.4	0.6
N	9.8	10.2



## D8JA05 THRU D8JA100

---

### Disclaimer

The information presented in this document is for reference only. Yangzhou Yangjie Electronic Technology Co., Ltd. reserves the right to make changes without notice for the specification of the products displayed herein to improve reliability, function or design or otherwise.

The product listed herein is designed to be used with ordinary electronic equipment or devices, and not designed to be used with equipment or devices which require high level of reliability and the malfunction of which would directly endanger human life (such as medical instruments, transportation equipment, aerospace machinery, nuclear-reactor controllers, fuel controllers and other safety devices), Yangjie or anyone on its behalf, assumes no responsibility or liability for any damages resulting from such improper use of sale.

This publication supersedes & replaces all information previously supplied. For additional information, please visit our website [http:// www.21yangjie.com](http://www.21yangjie.com) , or consult your nearest Yangjie's sales office for further assistance.